

## 1 to 25 kVA

### Applications

- Class I Division 2 units are used in hazardous locations to maintain a safe environment.

### Specifications

- Class I Division 2, Groups A, B, C, D
- T3C temperature classification
- 60 Hz operation
- Single Phase: 1 – 25 kVA
- Three Phase: 3 – 75 kVA
- Aluminum windings
- 115°C temperature rise with 40°C ambient
- 180°C insulation class
- Encapsulated with electrical grade resin
- NEMA3R-rated enclosures
- Cores of high quality electrical steel
- Heat-cured ASA-61 gray powder coat finish

### Features, Functions, Benefits

- Large connection compartment with knockouts for ease of wiring and installation
- Slotted mounting holes for quick and easy mounting
- Lifting hooks above 5 kVA
- Wall mount design through 25 kVA
- Seismic certification for all units



### Standards

- Built in accordance with NEMA, ANSI, and CSA standards

### Options and Accessories

- 50/60 Hz optional
- Other sizes, voltages available
- Copper windings
- 304 or 316 grade stainless steel enclosure to meet corrosion resistance requirements.
- CE Marked units available as custom

### Approvals



## Enclosure Figures

Figure 2

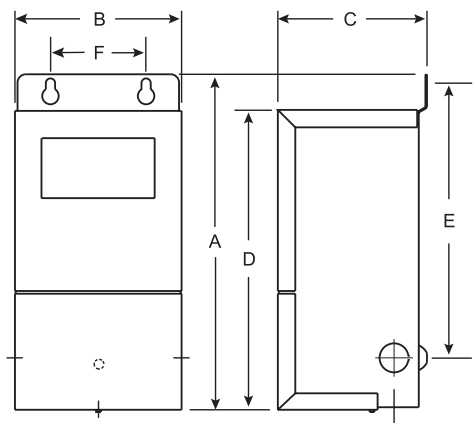

Figure 3

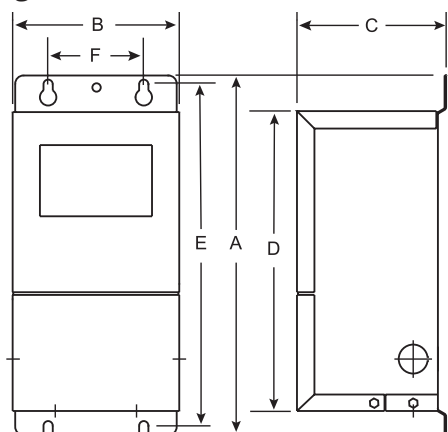
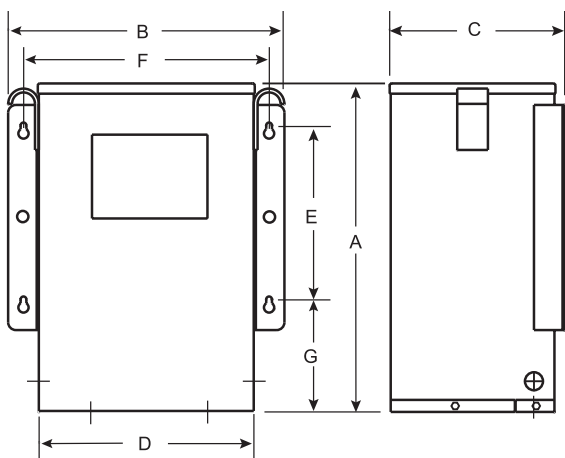

Figure 4



## Model Numbers Defined

411-2XXY-ABC

Single-Phase, Encapsulated  
Wall Mount  
Standard 411  
International 511

Type  
Class I, Div 2 2

kVA Rating / XX	kVA Rating / XX
0.5 05	6.0 12
0.75 06	7.5 13
1.0 07	9.0 14
1.5 08	10.0 15
2.0 09	15.0 16
3.0 10	20.0 17
5.0 11	25.0 18

Primary	Secondary
120x240	120/240 1
208	120/240 2
240x480	120/240 3
277	120/240 4
600	120/240 5
120 Min 600 Max	120 Min 600 Max 6
480	120/240 7

Wiring  
Default 0  
Copper 8

Temperature Rise, Shields  
all models 40°C ambient

135°C Rise, no shield	0
135°C Rise, with shield	1
95°C Rise, no shield	2
95°C Rise, with shield	3
80°C Rise, no shield	4
80°C Rise, with shield	5
115°C Rise, no shield	6
115°C Rise, with shield	7

Taps  
No taps 0  
2@2.5% FCBN 1  
2@2.5% FCAN, 2@2.5 FCBN 2  
4@2.5% FCBN 3  
2@5% FCBN 4  
1@5% FCAN, 1@5% FCBN 5  
2@5% FCAN, 4@2.5 FCBN 6

**Class I Division 2, Single Phase**

115°C Temperature Rise, 40°C ambient

<b>120 x 240V — 120/240V, Taps: None</b>											
kVA	Catalog Number	Enclosure Figure	Height (A) inches	Width (B) inches	Depth (C) inches	(D) inches	(E) inches	(F) inches	(G) inches	Est Ship Wgt	Wiring Diagram
1.0	411-2071-060	2	10.2	5.1	4.6	9.1	8.4	2.25		18	S240A
2.0	411-2091-060	3	12.5	6.7	5.4	10.6	12	2.25		41	S240A
3.0	411-2101-060	3	14.6	7.6	7.2	12.7	14.1	3.5		68	S240A
5.0	411-2111-060	3	16.1	13.5	8.6	10.6	8.25	5.5	12.0	98	S240A
7.5	411-2131-060	4	16.1	13.5	8.6	10.6	8.25	5.5	12.0	130	S240A
10.0	411-2151-060	4	21.1	16.5	10.1	13.7	12.5	6.25	15.0	255	S240A
15.0	411-2161-060	4	21.1	16.5	10.1	13.7	12.5	6.25	15.0	255	S240A
25.0	411-2181-060	4	TBD	TBD	TBD	TBD	TBD	TBD	TBD	TBD	S240A
<b>208V — 120/240V, Taps: None</b>											
1.0	411-2072-060	2	10.2	5.1	4.6	9.1	8.4	2.3		19	S208A
1.5	411-2082-060	3	12.5	6.7	5.3	10.6	12.0	2.3		33	S208A
2.0	411-2092-060	3	12.5	6.7	5.3	10.6	12.0	2.3		41	S208A
3.0	411-2102-060	3	14.6	7.6	7.2	12.7	14.1	3.5		68	S208A
5.0	411-2112-060	3	14.6	7.6	7.2	12.7	14.1	3.5		93	S208A
7.5	411-2132-060	4	16.1	13.5	8.6	10.6	8.3	5.5	12.0	130	S208A
10.0	411-2152-060	4	16.1	13.5	8.6	10.6	8.3	5.5	12.0	155	S208A
15.0	411-2162-060	4	21.1	16.5	10.1	13.7	12.5	6.3	15.0	255	S208A
25.0	411-2182-060	4	TBD	TBD	TBD	TBD	TBD	TBD	TBD	TBD	S208A
<b>240 x 480V — 120/240V • Taps: None</b>											
1.0	411-2073-060	2	10.2	5.1	4.6	9.1	8.4	2.3		19	S480A
2.0	411-2093-060	3	12.5	6.7	5.3	10.6	12.0	2.3		41	S480A
3.0	411-2103-060	3	14.6	7.6	7.2	12.7	14.1	3.5		68	S480A
5.0	411-2113-060	3	14.6	7.6	7.2	12.7	14.1	3.5		93	S480A
7.5	411-2133-060	4	16.1	13.5	8.6	10.6	8.3	5.5	12.0	130	S480A
10.0	411-2153-060	4	16.1	13.5	8.6	10.6	8.3	5.5	12.0	155	S480A
15.0	411-2163-060	4	21.1	16.5	10.1	13.7	12.5	6.3	15.0	255	S480A
25.0	411-2183-060	4	TBD	TBD	TBD	TBD	TBD	TBD	TBD	TBD	S480A

See website for additional kVA, copper windings and temperature options.

Housing dimensions subject to change without notice. Consult website or factory where dimensions are critical.

Use the "Find a Product" tool for detailed specification sheets.

For further information, contact an Application Engineer at 800-892-3755, [technical\\_services@jeffersonelectric.com](mailto:technical_services@jeffersonelectric.com)

**Class I Division 2, Single Phase**

115°C Temperature Rise, 40°C ambient

<b>240 x 480V — 120/240V • Taps: 2 @ 2.5% FCAN + 2 @ 2.5% FCBN</b>											
kVA	Catalog Number	Enclosure Figure	Height (A) inches	Width (B) inches	Depth (C) inches	(D) inches	(E) inches	(F) inches	(G) inches	Est Ship Wgt	Wiring Diagram
3	411-2103-062	3	14.6	7.6	7.2	12.7	14.1	3.5		68	S480B
5	411-2113-062	3	14.6	7.6	7.2	12.7	14.1	3.5		93	S480B
7.5	411-2133-062	4	16.1	13.5	8.6	10.6	8.25	5.5	12.0	130	S480B
10	411-2153-062	4	16.1	13.5	8.6	10.6	8.25	5.5	12.0	155	S480B
15	411-2163-062	4	21.1	16.5	10.1	13.7	12.5	6.3	15.0	255	S480B
25	411-2183-062	4	21.1	16.5	10.1	13.7	12.5	6.3	15.0	291	S480B
<b>277V — 120/240V • Taps: 2 @ 2.5% FCBN</b>											
1	411-2074-061	2	10.2	5.1	4.6	9.1	8.4	2.3		19	S277A
2	411-2094-061	3	12.5	6.7	5.3	10.6	12.0	2.3		41	S277A
3	411-2104-061	3	14.6	7.6	7.2	12.7	14.1	3.5		68	S277A
5	411-2114-061	3	14.6	7.6	7.2	12.7	14.1	3.5		93	S277A
7.5	411-2134-061	4	16.1	13.5	8.6	10.6	8.25	5.5	12.0	130	S277A
10	411-2154-061	4	16.1	13.5	8.6	10.6	8.25	5.5	12.0	155	S277A
15	411-2164-061	4	21.1	16.5	10.1	13.7	12.5	6.3	15.0	255	S277A
25	411-2184-061	4	21.1	16.5	10.1	13.7	12.5	6.3	15.0	291	S277A
<b>600V — 120/240V • Taps: 2 @ 2.5% FCAN + 2 @ 2.5% FCBN</b>											
1	411-2075-062	2	10.2	5.1	4.6	9.1	8.4	2.3		19	S600B
2	411-2095-062	3	12.5	6.7	5.3	10.6	12.0	2.3		41	S600B
3	411-2105-062	3	14.6	7.6	7.2	12.7	14.1	3.5		68	S600B
5	411-2115-062	3	14.6	7.6	7.2	12.7	14.1	3.5		93	S600B
7.5	411-2135-062	4	16.1	13.5	8.6	10.6	8.25	5.5	12.0	130	S600B
10	411-2155-062	4	16.1	13.5	8.6	10.6	8.25	5.5	12.0	155	S600B
15	411-2165-062	4	21.1	16.5	10.1	13.7	12.5	6.3	15.0	255	S600B
25	411-2185-062	4	21.1	16.5	10.1	13.7	12.5	6.3	15.0	291	S600B

See website for additional kVA, copper windings and temperature options.  
 Housing dimensions subject to change without notice. Consult website or factory where dimensions are critical.  
 Use the "Find a Product" tool for detailed specification sheets.  
 For further information, contact an Application Engineer at 800-892-3755, [technical\\_services@jeffersonelectric.com](mailto:technical_services@jeffersonelectric.com)

**Wiring Diagrams**

**S208A** Wiring Diagram & Connections

**Wiring Diagram**

Primary: 208 Volts Delta  
Secondary: 120/240 Volts

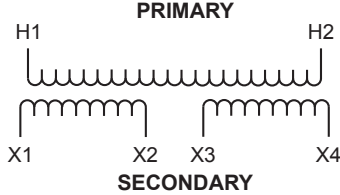

**Connections**

Primary Volts	Primary Lines Connect To	
208	H1, H2	
Secondary Volts	Interconnect	Secondary Lines Connect To
240	X2 to X3	X1, X4
120/240	X2 to X3	X1, X2, X4
120	X1 to X3 X2 to X4	X1, X4

**S240A** Wiring Diagram & Connections

**Wiring Diagram**

Primary: 120 x 240 Volts Delta  
Secondary: 120/240 Volts

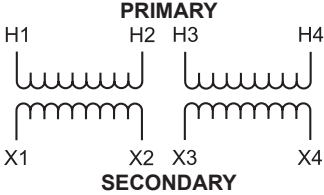

**Connections**

Primary Volts	Interconnect	Primary Lines Connect To
240	H2 to H3	H1, H4
120	H1 to H3 H2 to H4	H1, H4
Secondary Volts	Interconnect	Secondary Lines Connect To
240	X2 to X3	X1, X4
120/240	X2 to X3	X1, X2, X4
120	X1 to X3 X2 to X4	X1, X4

**S277A** Wiring Diagram & Connections

**Wiring Diagram**

Primary: 277 Volts Delta  
Secondary: 120/240 Volts

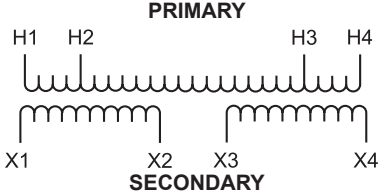

**Connections**

Primary Volts	Primary Lines Connect To	
277	H1, H4	
270	H1, H3	
263	H1, H4	
Secondary Volts	Interconnect	Secondary Lines Connect To
240	X2 to X3	X1, X4
120/240	X2 to X3	X1, X2, X4
120	X1 to X3 X2 to X4	X1, X4

**S480A** Wiring Diagram & Connections

**Wiring Diagram**

Primary: 240 x 480 Volts Delta  
Secondary: 120/240 Volts

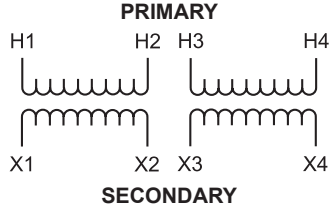

**Connections**

Primary Volts	Interconnect	Primary Lines Connect To
480	H2 to H3	H1, H4
240	H1 to H3 H2 to H4	H1, H4
Secondary Volts	Interconnect	Secondary Lines Connect To
240	X2 to X3	X1, X4
120/240	X2 to X3	X1, X2, X4
120	X1 to X3 X2 to X4	X1, X4

**S600B** Wiring Diagram & Connections

**Wiring Diagram**

Primary: 600 Volts Delta  
Secondary: 120/240 Volts

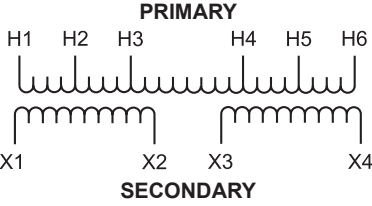

**Connections**

Primary Volts	Primary Lines Connect To	
600	H1, H6	
585	H1, H5	
570	H2, H5	
555	H2, H4	
540	H3, H4	
Secondary Volts	Interconnect	Secondary Lines Connect To
240	X2 to X3	X1, X4
120/240	X2 to X3	X1, X2, X4
120	X1 to X3 X2 to X4	X1, X4

**S480B** Wiring Diagram & Connections

**Wiring Diagram**

Primary: 240 x 480 Volts Delta  
Secondary: 120/240 Volts

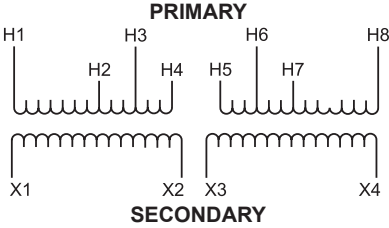

**Connections**

Primary Volts	Interconnect	Primary Lines Connect To
504	H4 to H5	H1 and H8
492	H3 to H5	H1 and H8
480	H3 to H6	H1 and H8
468	H2 to H6	H1 and H8
456	H2 to H7	H1 and H8
252	H1 to H5 H4 to H8	H1 and H8
240	H1 to H6 H3 to H8	H1 and H8
228	H1 to H7 H2 to H8	H1 and H8
Secondary Volts	Interconnect	Secondary Lines Connect To
240	X2 to X3	X1 and X4
120/240	X2 to X3	X1, X2, X4
120	X1 to X3 X2 to X4	X1, X4

More wiring diagrams can be found in catalog's appendix, section 15.  
Use the "Find a Product" tool on our website for detailed specification sheets.  
For further information, contact an Application Engineer at 800-892-3755,  
technical\_services@jeffersonelectric.com



### Enclosure Figures

Figure 4

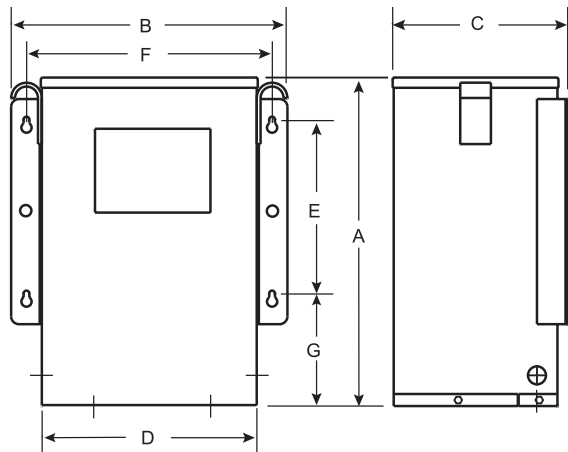
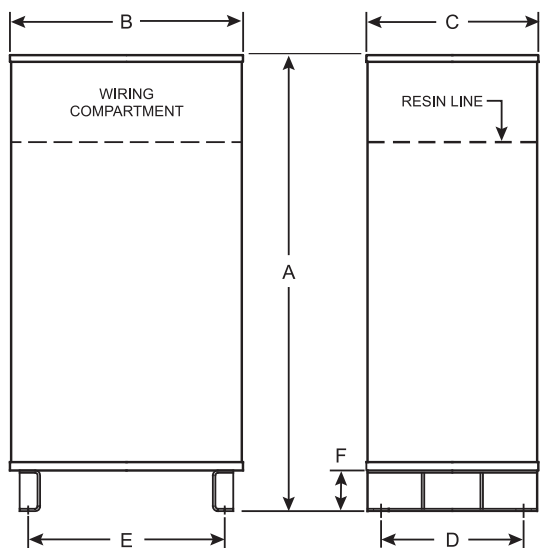

Figure 21



### Model Numbers Defined

413-2XXY-ABC

Three-Phase, Encapsulated		Type	
		Class I, Div 2 2	
kVA Rating / XX		kVA Rating / XX	
3	10	20	17
5	11	25	18
6	12	30	19
7.5	13	37.5	20
9	14	45	21
10	15	50	22
15	16	75	23
Primary		Secondary	
208	480-Y/277		1
240	208Y/120		2
240	480Y/277		3
480	208Y/120		4
480	480Y/277		5
120 Min 600 Max	120 Min 600 Max		*6
480	120/240		7
208	208Y/120		8
600	208Y/120		9
* Unit is special. Suffix will not break down per this chart			
		Wiring	
		Default 0	
		Copper 8	
		Temperature Rise (40°C ambient)	
		135°C Rise 0	
		115°C Rise 1	
		70°C Rise 7	
		80°C Rise 8	
		95°C Rise 9	
		Shield	
		Shield 0	
		No shield 5	

**Class I Division 2, Three Phase**

115°C Temperature Rise, 40°C ambient

<b>208 Volts - 208/120 Volts • Taps: 2 @ 5% FCBN</b>											
kVA	Catalog Number	Enclosure Figure	Height (A) inches	Width (B) inches	Depth (C) inches	(D) inches	(E) inches	(F) inches	(G) inches	Est Ship Wgt	Wiring Diagram
3	413-2108-010	4	13.1	15.1	8.1	12.3	5.25	5.5	13.6	110	T208H
6	413-2128-010	4	13.1	15.1	8.1	12.3	5.25	5.5	13.6	140	T208H
9	413-2148-010	4	15.1	19	9.1	16.1	8.25	5.1	17.5	190	T208H
15	413-2168-010	4	15.1	19	9.1	16.1	8.25	5.1	17.5	245	T208H
30	413-2198-010	21	33	23	9.5	7	20.5	3	1.5	890	T208H
45	413-2218-010	21	36	25	12.5	8.5	21.75	3	1.5	790	T208H
75	413-2238-010	21	37	25	12.5	10.5	22.5	3	1.5	1,050	T208H
<b>208 Volts - 480/277 Volts • Taps: 2 @ 5% FCBN</b>											
3	413-2101-010	4	13.1	15.1	8.1	12.3	5.25	5.5	13.6	110	T208A
6	413-2121-010	4	13.1	15.1	8.1	12.3	5.25	5.5	13.6	140	T208A
9	413-2141-010	4	15.1	19	9.1	16.1	8.25	5.1	17.5	190	T208A
15	413-2161-010	4	15.1	19	9.1	16.1	8.25	5.1	17.5	245	T208A
30	413-2191-010	21	33	23	9.5	7	20.5	3	1.5	890	T208A
45	413-2211-010	21	36	25	12.5	8.5	21.75	3	1.5	790	T208A
75	413-2231-010	21	37	25	12.5	10.5	22.5	3	1.5	1,050	T208A
<b>240 Volts - 208Y/120 Volts • Taps: 2 @ 5% FCBN</b>											
3	413-2102-010	4	13.1	15.1	8.1	12.3	5.25	5.5	13.6	110	T240A
6	413-2122-010	4	13.1	15.1	8.1	12.3	5.25	5.5	13.6	140	T240A
9	413-2142-010	4	15.1	19	9.1	16.1	8.25	5.1	17.5	190	T240A
15	413-2162-010	4	15.1	19	9.1	16.1	8.25	5.1	17.5	245	T240A
30	413-2192-010	21	33	23	9.5	7	20.5	3	1.5	890	T240A
45	413-2212-010	21	36	25	12.5	8.5	21.75	3	1.5	790	T240A
75	413-2232-010	21	37	25	12.5	10.5	22.5	3	1.5	1,050	T240A
<b>240 Volts - 480/277 Volts • Taps: 2 @ 5% FCBN</b>											
3	413-2103-010	4	13.1	15.1	8.1	12.3	5.25	5.5	13.6	110	T240G
6	413-2123-010	4	13.1	15.1	8.1	12.3	5.25	5.5	13.6	140	T240G
9	413-2143-010	4	15.1	19	9.1	16.1	8.25	5.1	17.5	190	T240G
15	413-2163-010	4	15.1	19	9.1	16.1	8.25	5.1	17.5	245	T240G
30	413-2193-010	21	33	23	9.5	7	20.5	3	1.5	890	T240G
45	413-2213-010	21	36	25	12.5	8.5	21.75	3	1.5	790	T240G
75	413-2233-010	21	37	25	12.5	10.5	22.5	3	1.5	1,050	T240G

See website for additional kVA, copper windings and temperature options.

Housing dimensions subject to change without notice. Consult website or factory where dimensions are critical.

Use the "Find a Product" tool for detailed specification sheets.

For further information, contact an Application Engineer at 800-892-3755, [technical\\_services@jeffersonelectric.com](mailto:technical_services@jeffersonelectric.com)

**Class I Division 2, Three Phase**

115°C Temperature Rise, 40°C ambient

<b>480 Volts - 208Y/120 Volts • Taps: 2 @ 5% FCBN</b>												
kVA	Catalog Number	Enclosure Figure	Height (A) inches	Width (B) inches	Depth (C) inches	(D) inches	(E) inches	(F) inches	(G) inches	Est Ship Wgt	Wiring Diagram	
3	413-2104-010	4	13.1	15.1	8.1	12.3	5.25	5.5	13.6	110	T480A	
6	413-2124-010	4	13.1	15.1	8.1	12.3	5.25	5.5	13.6	140	T480A	
9	413-2144-010	4	15.1	19	9.1	16.1	8.25	5.1	17.5	190	T480A	
15	413-2164-010	4	15.1	19	9.1	16.1	8.25	5.1	17.5	245	T480A	
30	413-2194-010	21	33	23	9.5	7	20.5	3	1.5	890	T480A	
45	413-2214-010	21	36	25	12.5	8.5	21.75	3	1.5	790	T480A	
75	413-2234-010	21	37	25	12.5	10.5	22.5	3	1.5	1,050	T480A	
<b>480 Volts - 240 Volts • Taps: 2 @ 5% FCBN</b>												
3	413-2107-010	4	13.1	15.1	8.1	12.3	5.25	5.5	13.6	110	T480B	
6	413-2127-010	4	13.1	15.1	8.1	12.3	5.25	5.5	13.6	140	T480B	
9	413-2147-010	4	15.1	19	9.1	16.1	8.25	5.1	17.5	190	T480B	
15	413-2167-010	4	15.1	19	9.1	16.1	8.25	5.1	17.5	245	T480B	
30	413-2197-010	21	33	23	9.5	7	20.5	3	1.5	890	T480B	
45	413-2217-010	21	36	25	12.5	8.5	21.75	3	1.5	790	T480B	
75	413-2237-010	21	37	25	12.5	10.5	22.5	3	1.5	1,050	T480B	
<b>480 Volts - 480/277 Volts • Taps: 2 @ 5% FCBN</b>												
3	413-2105-010	4	13.1	15.1	8.1	12.3	5.25	5.5	13.6	110	T480C	
6	413-2125-010	4	13.1	15.1	8.1	12.3	5.25	5.5	13.6	140	T480C	
9	413-2145-010	4	15.1	19	9.1	16.1	8.25	5.1	17.5	190	T480C	
15	413-2165-010	4	15.1	19	9.1	16.1	8.25	5.1	17.5	245	T480C	
30	413-2195-010	21	33	23	9.5	7	20.5	3	1.5	890	T480C	
45	413-2215-010	21	36	25	12.5	8.5	21.75	3	1.5	790	T480C	
75	413-2235-010	21	37	25	12.5	10.5	22.5	3	1.5	1,050	T480C	
<b>600 Volts - 208/120 Volts • Taps: 2 @ 5% FCBN</b>												
3	413-2109-010	4	13.1	15.1	8.1	12.3	5.25	5.5	13.6	110	T600A	
6	413-2129-010	4	13.1	15.1	8.1	12.3	5.25	5.5	13.6	140	T600A	
9	413-2149-010	4	15.1	19	9.1	16.1	8.25	5.1	17.5	190	T600A	
15	413-2169-010	4	15.1	19	9.1	16.1	8.25	5.1	17.5	245	T600A	
30	413-2199-010	21	33	23	9.5	7	20.5	3	1.5	890	T600A	
45	413-2219-010	21	36	25	12.5	8.5	21.75	3	1.5	790	T600A	
75	413-2239-010	21	37	25	12.5	10.5	22.5	3	1.5	1,050	T600A	

See website for additional kVA, copper windings and temperature options.  
 Housing dimensions subject to change without notice. Consult website or factory where dimensions are critical.  
 Use the "Find a Product" tool for detailed specification sheets.  
 For further information, contact an Application Engineer at 800-892-3755, [technical\\_services@jeffersonelectric.com](mailto:technical_services@jeffersonelectric.com)



**Wiring Diagrams**

**T208A** Wiring Diagram & Connections

**Wiring Diagram**

Primary: 208 Volts Delta  
Secondary: 480Y/277 Volts

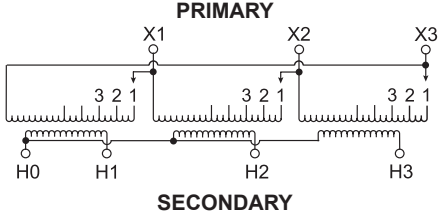

**Connections**

Primary Volts	On Each Coil Jumper Taps To	Primary Lines Connect To
208	1	X1, X2, X3
198	2	X1, X2, X3
187	3	X1, X2, X3
Secondary Volts	Secondary Lines Connect To	
480	H1, H2, H3	
277	Between H0 and H1 or H2 or H3	
1 Phase		

**T208H** Wiring Diagram & Connections

**Wiring Diagram**

Primary: 208 Volts Delta  
Secondary: 208Y/120 Volts

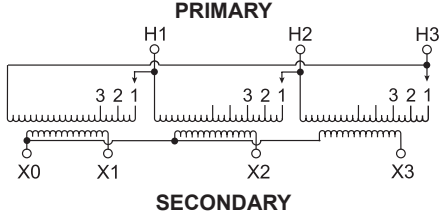

**Connections**

Primary Volts	On Each Coil Jumper Taps To	Primary Lines Connect To
208	1	H1, H2, H3
198	2	H1, H2, H3
187	3	H1, H2, H3
Secondary Volts	Secondary Lines Connect To	
208	X1, X2, X3	
120	Between X0 and X1 or X2 or X3	
1 Phase		

**T240A** Wiring Diagram & Connections

**Wiring Diagram**

Primary: 240 Volts Delta  
Secondary: 208Y/120 Volts

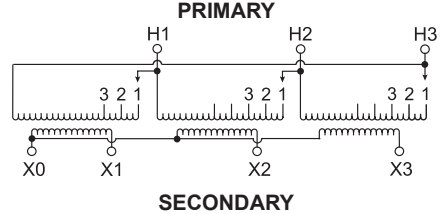

**Connections**

Primary Volts	On Each Coil Jumper Taps To	Primary Lines Connect To
240	1	H1, H2, H3
228	2	H1, H2, H3
216	3	H1, H2, H3
Secondary Volts	Secondary Lines Connect To	
208	X1, X2, X3	
120	Between X0 and X1 or X2 or X3	
1 Phase		

**T240G** Wiring Diagram & Connections

**Wiring Diagram**

Primary: 240 Volts Delta  
Secondary: 480Y/277 Volts

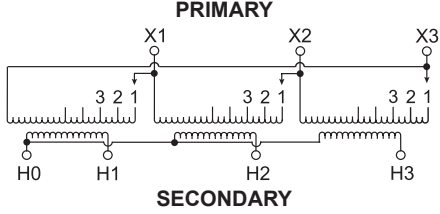

**Connections**

Primary Volts	On Each Coil Jumper Taps To	Primary Lines Connect To
240	1	X1, X2, X3
228	2	X1, X2, X3
216	3	X1, X2, X3
Secondary Volts	Secondary Lines Connect To	
480	H1, H2, H3	
277	Between H0 and H1 or H2 or H3	
1 Phase		

More wiring diagrams can be found in catalog's appendix, section 15. Use the "Find a Product" tool on our website for detailed specification sheets. For further information, contact an Application Engineer at 800-892-3755, [technical\\_services@jeffersonelectric.com](mailto:technical_services@jeffersonelectric.com)

## Wiring Diagrams

### T480A Wiring Diagram & Connections

#### Wiring Diagram

Primary: 480 Volts Delta  
Secondary: 208Y/120 Volts

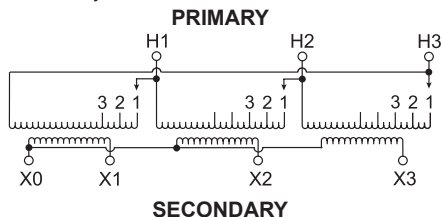

#### Connections

Primary Volts	On Each Coil Jumper Taps To	Primary Lines Connect To
480	1	H1, H2, H3
456	2	H1, H2, H3
432	3	H1, H2, H3
Secondary Volts	Secondary Lines Connect To	
208	X1, X2, X3	
120	Between X0 and X1 or X2 or X3	
1 Phase		

### T480B Wiring Diagram & Connections

#### Wiring Diagram

Primary: 480 Volts Delta  
Secondary: 240 Volts Delta

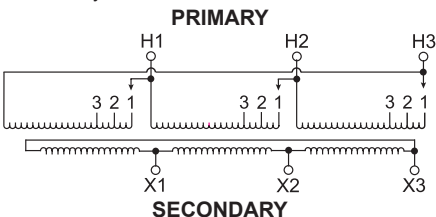

#### Connections

Primary Volts	On Each Coil Jumper Taps To	Primary Lines Connect To
480	1	H1, H2, H3
456	2	H1, H2, H3
432	3	H1, H2, H3
Secondary Volts	Secondary Lines Connect To	
240	X1, X2, X3	

### T480C Wiring Diagram & Connections

#### Wiring Diagram

Primary: 480 Volts Delta  
Secondary: 480Y/277 Volts

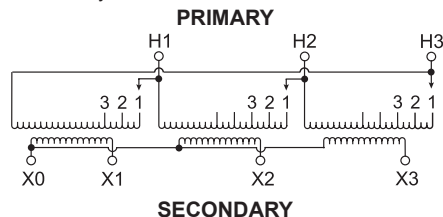

#### Connections

Primary Volts	On Each Coil Jumper Taps To	Primary Lines Connect To
480	1	H1, H2, H3
456	2	H1, H2, H3
432	3	H1, H2, H3
Secondary Volts	Secondary Lines Connect To	
480	X1, X2, X3	
277	Between X0 and X1 or X2 or X3	
1 Phase		

### T600A Wiring Diagram & Connections

#### Wiring Diagram

Primary: 600 Volts Delta  
Secondary: 208Y/120 Volts

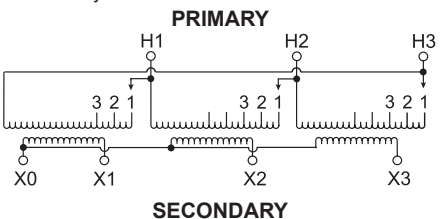

#### Connections

Primary Volts	On Each Coil Jumper Taps To	Primary Lines Connect To
600	1	H1, H2, H3
570	2	H1, H2, H3
540	3	H1, H2, H3
Secondary Volts	Secondary Lines Connect To	
208	X1, X2, X3	
120	Between X0 and X1 or X2 or X3	
1 phase		

More wiring diagrams can be found in catalog's appendix, section 15. Use the "Find a Product" tool on our website for detailed specification sheets. For further information, contact an Application Engineer at 800-892-3755, [technical\\_services@jeffersonelectric.com](mailto:technical_services@jeffersonelectric.com)