

3 to 990 kVA

Applications

- For industrial and commercial applications with SCR-controlled adjustable speed motor drives, and AC adjustable frequency or DC drives

Specifications

- NEMA1 rated enclosures
- Three-Phase Encapsulated 3 through 11 kVA
- Three-Phase Ventilated 14 through 990 kVA
- 60 Hz operation
- Aluminum windings
- 150°C temperature rise
- 220°C insulation class units
- Electrostatic shield
- Heat-cured ASA-61 gray powder coat finish
- Cores of high quality electrical steel
- Primary taps

Features, Functions, Benefits

- Large connection compartment for ease of wiring and installation
- Complete kVA range to cover standard drive systems
- Internally braced for short circuit stress protection
- Low impedance for better voltage regulation
- Low flux density to minimize core saturation
- Tap arrangements provided to compensate for input voltage variation
- Quiet operation for installation flexibility
- Seismic certification for all units

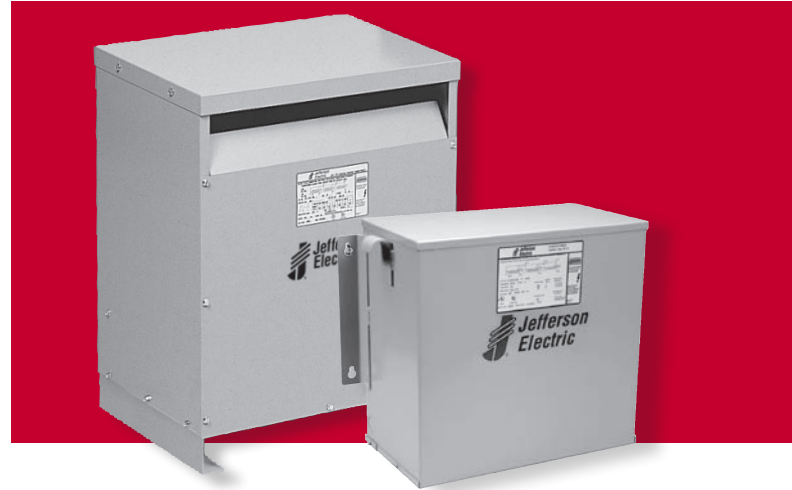

Standards

- Built in accordance with NEMA, ANSI, UL and CSA standards

Options and Accessories

- 50/60 Hz optional
- Other sizes, voltages and temperature rises available
- Copper windings
- Wall mount brackets available through 75 kVA

Approvals



Enclosure Figures

Figure 4

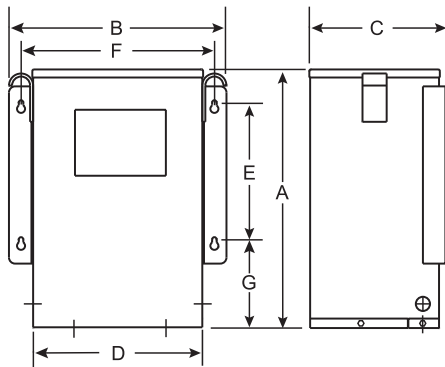
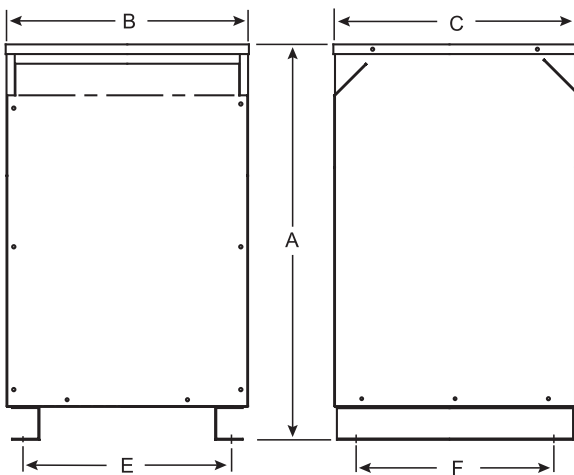

Figure 7



Drive Selection

To determine the proper size drive isolation transformer, locate the HP of the motors to be operated in the left hand column. The corresponding figure in the right hand column is the recommended transformer kVA. Use the Product Selector on our website to find your model.

Drive Selector Chart

HP	kVA
2	3
3	6
5	7.5
7.5	11
10	14
15	20
20	27
25	34
30	40
40	51
50	63
60	75
75	93
100	118
125	145
150	175
200	220
250	275
300	330
400	440
500	550

Wall Mounting Bracket Kits

Part Number	Description	Capacity (lbs)
223-7008-030	For 14 to 20 kVA units, 150°C rise	250
223-7008-075	For 27 to 75 kVA units, 150°C rise	750

Drive Isolation Transformers

Designed for use with motor drives, the drive isolation transformer must isolate the motor from the line and handle the added loads of the drive-created harmonics. Jefferson Electric’s drive isolation transformers are custom engineered for both AC adjustable frequency and DC motor drives. They are specifically designed to accommodate the electrical and mechanical stresses, regenerative current reversals and frequent short circuits inherent in severe drive duty cycles.

Following is a representative list of the models available:

US Standard Efficiency			
Primary	Secondary	Taps	Wiring Diagram
230V Delta	230Y/133V	1 @ 5% FCAN & 1 @ 5% FBCN	DIT CC
230V Delta	460Y/266V	1 @ 5% FCAN & 1 @ 5% FBCN	DIT CG
460V Delta	230Y/133V	1 @ 5% FCAN & 1 @ 5% FBCN	DIT GC
460V Delta	460Y/266V	1 @ 5% FCAN & 1 @ 5% FBCN	DIT GG
575V Delta	230Y/133V	1 @ 5% FCAN & 1 @ 5% FBCN	DIT LC
575V Delta	460Y/266V	1 @ 5% FCAN & 1 @ 5% FBCN	DIT LG
Canadian C802 Compliant			
240V Delta	240Y/139V	1 @ 5% FCAN & 1 @ 5% FBCN	DIT DD
240V Delta	480Y/277V	1 @ 5% FCAN & 1 @ 5% FBCN	DIT DH
480V Delta	240Y/139V	1 @ 5% FCAN & 1 @ 5% FBCN	DIT HD
480V Delta	480Y/277V	1 @ 5% FCAN & 1 @ 5% FBCN	DIT HH
600V Delta	240Y/139V	1 @ 5% FCAN & 1 @ 5% FBCN	DIT MD
600V Delta	480Y/277V	1 @ 5% FCAN & 1 @ 5% FBCN	DIT MH

See website for kVA, copper windings and temperature options.

Use the “Find a Product” tool for detailed specification sheets.

For further information, contact an Application Engineer at 800-892-3755, technical_services@jeffersonelectric.com



Wiring Diagrams US Standard Efficiency

DIT CC Wiring Diagram & Connections

Wiring Diagram

Primary: 230 Volts Delta
Secondary: 230Y/133 Volts

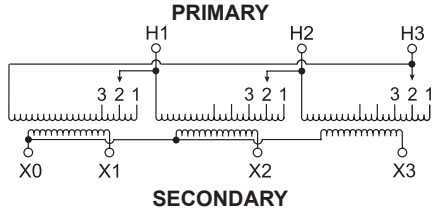

Connections

Primary Volts	On Each Coil Jumper Taps To	Primary Lines Connect To
242	1	H1, H2, H3
230	2	H1, H2, H3
218	3	H1, H2, H3
Secondary Volts	Secondary Lines Connect To	
230	X1, X2, X3	
133	Between X0 and X1 or X2 or X3	
1 Phase		

DIT CG Wiring Diagram & Connections

Wiring Diagram

Primary: 230 Volts Delta
Secondary: 460Y/266 Volts

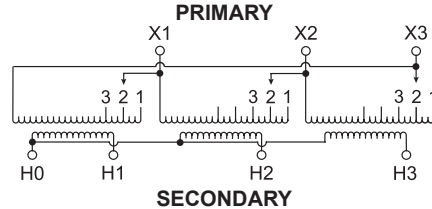

Connections

Primary Volts	On Each Coil Jumper Taps To	Primary Lines Connect To
242	1	X1, X2, X3
230	2	X1, X2, X3
218	3	X1, X2, X3
Secondary Volts	Secondary Lines Connect To	
460	H1, H2, H3	
266	Between H0 and H1 or H2 or H3	
1 Phase		

DIT GC Wiring Diagram & Connections

Wiring Diagram

Primary: 460 Volts Delta
Secondary: 230Y/133 Volts

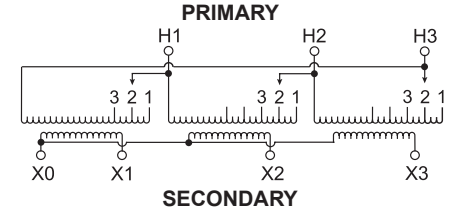

Connections

Primary Volts	On Each Coil Jumper Taps To	Primary Lines Connect To
483	1	H1, H2, H3
460	2	H1, H2, H3
437	3	H1, H2, H3
Secondary Volts	Secondary Lines Connect To	
230	X1, X2, X3	
133	Between X0 and X1 or X2 or X3	
1 Phase		

DIT GG Wiring Diagram & Connections

Wiring Diagram

Primary: 460 Volts Delta
Secondary: 460Y/266 Volts

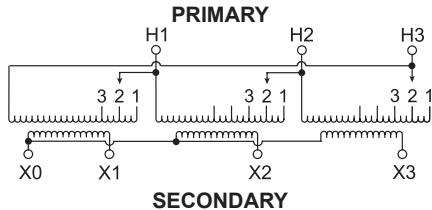

Connections

Primary Volts	On Each Coil Jumper Taps To	Primary Lines Connect To
483	1	H1, H2, H3
460	2	H1, H2, H3
437	3	H1, H2, H3
Secondary Volts	Secondary Lines Connect To	
460	X1, X2, X3	
266	Between X0 and X1 or X2 or X3	
1 Phase		

DIT LC Wiring Diagram & Connections

Wiring Diagram

Primary: 575 Volts Delta
Secondary: 230Y/133 Volts

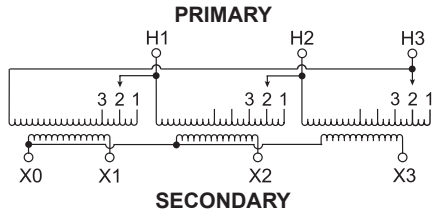

Connections

Primary Volts	On Each Coil Jumper Taps To	Primary Lines Connect To
604	1	H1, H2, H3
575	2	H1, H2, H3
546	3	H1, H2, H3
Secondary Volts	Secondary Lines Connect To	
230	X1, X2, X3	
133	Between X0 and X1 or X2 or X3	
1 Phase		

DIT LG Wiring Diagram & Connections

Wiring Diagram

Primary: 575 Volts Delta
Secondary: 460Y/266 Volts

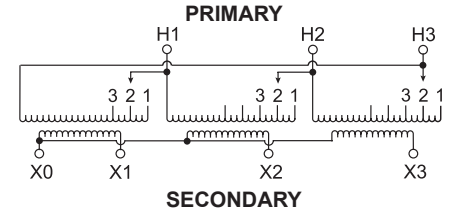

Connections

Primary Volts	On Each Coil Jumper Taps To	Primary Lines Connect To
604	1	H1, H2, H3
575	2	H1, H2, H3
546	3	H1, H2, H3
Secondary Volts	Secondary Lines Connect To	
460	X1, X2, X3	
266	Between X0 and X1 or X2 or X3	
1 Phase		

More wiring diagrams can be found in catalog's appendix, section 15.

Use the "Find a Product" tool on our website for detailed specification sheets.

For further information, contact an Application Engineer at 800-892-3755, technical_services@jeffersonelectric.com

Wiring Diagrams Canadian C802 Standard Efficiency

DIT DD Wiring Diagram & Connections

Wiring Diagram

Primary: 240 Volts Delta
Secondary: 240Y/139 Volts

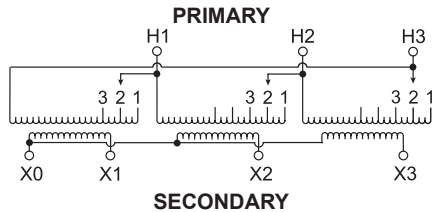

Connections

Primary Volts	On Each Coil Jumper Taps To	Primary Lines Connect To
252	1	H1, H2, H3
240	2	H1, H2, H3
228	3	H1, H2, H3
Secondary Volts	Secondary Lines Connect To	
240	X1, X2, X3	
139	Between X0 and X1 or X2 or X3	
1 Phase		

DIT DH Wiring Diagram & Connections

Wiring Diagram

Primary: 240 Volts Delta
Secondary: 480Y/277 Volts

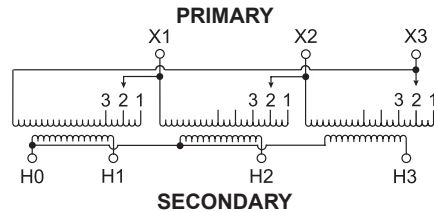

Connections

Primary Volts	On Each Coil Jumper Taps To	Primary Lines Connect To
252	1	H1, H2, H3
240	2	H1, H2, H3
228	3	H1, H2, H3
Secondary Volts	Secondary Lines Connect To	
480	X1, X2, X3	
277	Between X0 and X1 or X2 or X3	
1 Phase		

DIT HD Wiring Diagram & Connections

Wiring Diagram

Primary: 480 Volts Delta
Secondary: 240Y/139 Volts

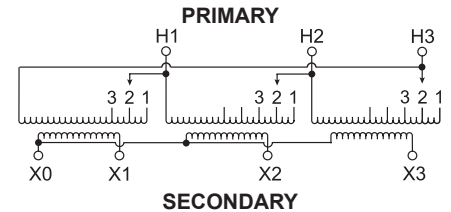

Connections

Primary Volts	On Each Coil Jumper Taps To	Primary Lines Connect To
504	1	H1, H2, H3
480	2	H1, H2, H3
456	3	H1, H2, H3
Secondary Volts	Secondary Lines Connect To	
240	X1, X2, X3	
139	Between X0 and X1 or X2 or X3	
1 Phase		

DIT HH Wiring Diagram & Connections

Wiring Diagram

Primary: 480 Volts Delta
Secondary: 480Y/277 Volts

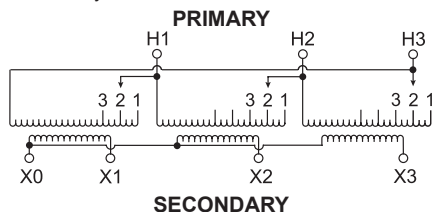

Connections

Primary Volts	On Each Coil Jumper Taps To	Primary Lines Connect To
504	1	H1, H2, H3
480	2	H1, H2, H3
456	3	H1, H2, H3
Secondary Volts	Secondary Lines Connect To	
480	X1, X2, X3	
277	Between X0 and X1 or X2 or X3	
1 Phase		

DIT MD Wiring Diagram & Connections

Wiring Diagram

Primary: 600 Volts Delta
Secondary: 240Y/139 Volts

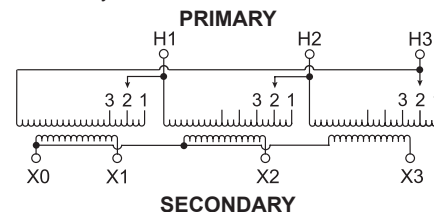

Connections

Primary Volts	On Each Coil Jumper Taps To	Primary Lines Connect To
630	1	H1, H2, H3
600	2	H1, H2, H3
570	3	H1, H2, H3
Secondary Volts	Secondary Lines Connect To	
240	X1, X2, X3	
139	Between X0 and X1 or X2 or X3	
1 Phase		

DIT MH Wiring Diagram & Connections

Wiring Diagram

Primary: 600 Volts Delta
Secondary: 480Y/277 Volts

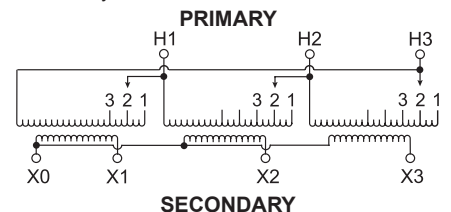

Connections

Primary Volts	On Each Coil Jumper Taps To	Primary Lines Connect To
630	1	H1, H2, H3
600	2	H1, H2, H3
570	3	H1, H2, H3
Secondary Volts	Secondary Lines Connect To	
480	X1, X2, X3	
277	Between X0 and X1 or X2 or X3	
1 Phase		

More wiring diagrams can be found in catalog's appendix, section 15.

Use the "Find a Product" tool on our website for detailed specification sheets.

For further information, contact an Application Engineer at 800-892-3755, technical_services@jeffersonelectric.com



