

Jefferson Electric

DRY TYPE TRANSFORMERS

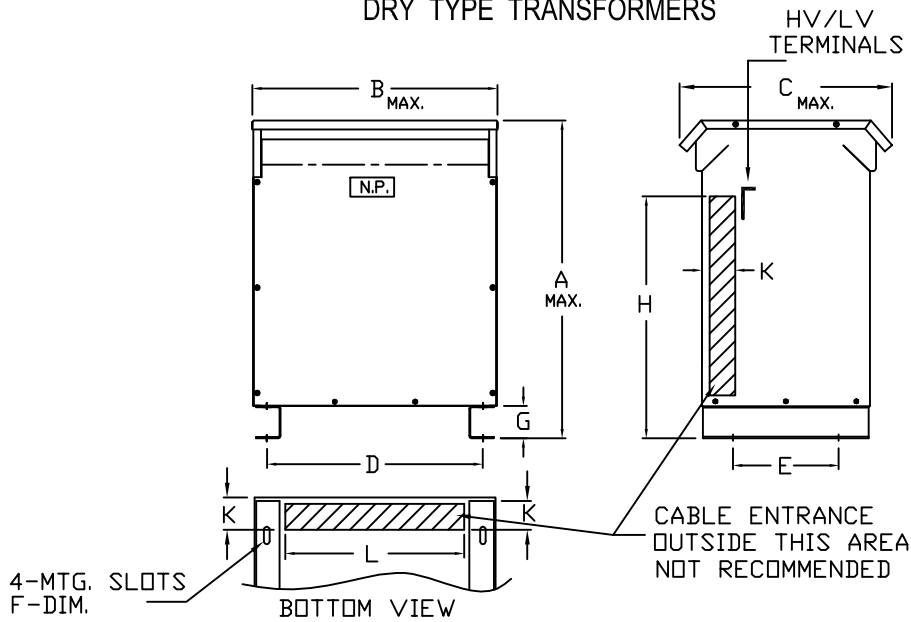

TEMP RISE	K-FACTOR	WINDINGS	EFFICIENCY
150	K-13	ALUMINUM	DOE-2016

DIMENSIONS IN (E)=INCHES & (M)=CENTIMETERS

KVA	NET WT. LBS.	A		B		C		D		E		F		G		H		K		L	
		E	M	E	M	E	M	E	M	E	M	E	M	E	M	E	M	E	M	E	M
		15	330	25.0	63.5	22.0	55.9	22.0	55.9	17.4	44.2	13.0	33.0	.56x1.13	1.42x2.87	3.0	7.6	13.0	33.0	3.0	7.6
30	415	28.0	71.1	25.0	63.5	23.5	59.7	20.8	52.7	14.5	36.8	.56x1.13	1.42x2.87	3.0	7.6	16.0	40.6	3.0	7.6	17.0	43.2
45	585	32.0	81.3	27.0	68.6	26.0	66.0	23.5	59.7	16.0	40.6	.56x1.13	1.42x2.87	3.0	7.6	18.0	45.7	3.0	7.6	20.0	50.8
75	795	38.0	96.5	29.0	73.7	29.0	73.7	25.5	64.8	18.0	45.7	.56x1.13	1.42x2.87	3.0	7.6	20.0	45.8	3.0	7.6	22.0	55.9
112.5	1035	42.0	107	33.0	83.8	32.5	82.6	29.5	74.9	21.0	53.3	.56x1.13	1.42x2.87	3.0	7.6	23.0	58.4	4.0	10.2	25.5	64.8
150	1430	46.0	117	35.0	88.9	37.0	94.0	31.5	80.0	25.0	63.5	.56x1.13	1.42x2.87	3.0	7.6	32.0	81.3	5.0	12.7	27.5	69.9
225	1755	52.0	132	35.0	88.9	37.0	94.0	31.5	80.0	25.0	63.5	.56x1.13	1.42x2.87	3.0	7.6	32.0	81.3	5.0	12.7	27.5	69.9
300	2760	60.0	154	48.0	122	43.5	110.5	42.0	107	27.0	68.6	.56x1.13	1.42x2.87	4.0	10.2	36.0	91.4	5.0	12.7	34.0	86.4
500	4150	72.0	183	52.0	132	44.0	112	34.0	86.4	42.0	107	.56x1.13	1.42x2.87	4.0	10.2	50.0	127	5.0	12.7	32.0	81.3
750		N/A																			
1000		N/A																			

NOTES:

- ALL UNITS ARE UL LISTED AND ARE DESIGNED IN ACCORDANCE WITH ANSI C89.2 AND NEMA ST-20 STANDARDS.
- THESE TRANSFORMERS UTILIZE A UL RECOGNIZED 220°C INSULATION SYSTEM.
- TRANSFORMERS ARE DRY TYPE, CLASS AA, VENTILATED ENCLOSURE FOR INDOOR OR OUTDOOR USE.
- FOR LIFTING OTHER THAN WITH FORK TRUCK, REMOVE TOP COVER AND USE CORE CLAMPS.
- PAINT COLOR IS ANSI #61 GRAY.
- FULL WIDTH COPPER ELECTROSTATIC SHIELD (OPTIONAL).
- 6' REQUIRED CLEARANCE FROM THE WALLS.
- HV/LV TERMINALS ARE TOP FRONT TERMINATED.
- NET. WEIGHTS ARE APPROXIMATE.
- MEETS DOE-2016 EFFICIENCY 10 CFR PART 431



GENERAL PURPOSE TRANSFORMERS
THREE-PHASE, 600 VOLTS CLASS, 60 HZ.

PCD 423-900A-150-K13

REV. A