

50 to 5,000 VA

Applications

- For commercial and industrial control applications including; control panels, conveyor systems, machine tool equipment, pump systems, and commercial air conditioning applications

Specifications

- Core and coil
- 50/60 Hz operation
- Machine wound copper coils
- Cores of high grade silicon steel
- 55°C temperature rise for 50 – 100 VA, insulation class of 105°C
- 80°C temperature rise for 150 – 750 VA, insulation class of 130°C
- 115°C temperature rise for 1,000 – 5,000 VA, insulation class of 180°C
- Phil-Slot-Hex head terminal screws
- Cores of high quality electrical steel
- Finger safe terminals on <=2kVA units (without secondary fuse clips)

Features, Functions, Benefits

- Permanently affixed wiring diagram
- Finger safe terminals on units 350 VA and below
- Slotted mounting holes for quick and easy mounting
- Secondary fuse clips standard on most units. The fuse clip is for a 13/32 x 1-1/2 midget fuse. The secondary fuse style is a matter of customer preference usually either time delay or fast acting.
- Wall mount design through 25 kVA
- Many sizes in stock and available for immediate shipment
- Units 2,000 VA and less are UPS shippable

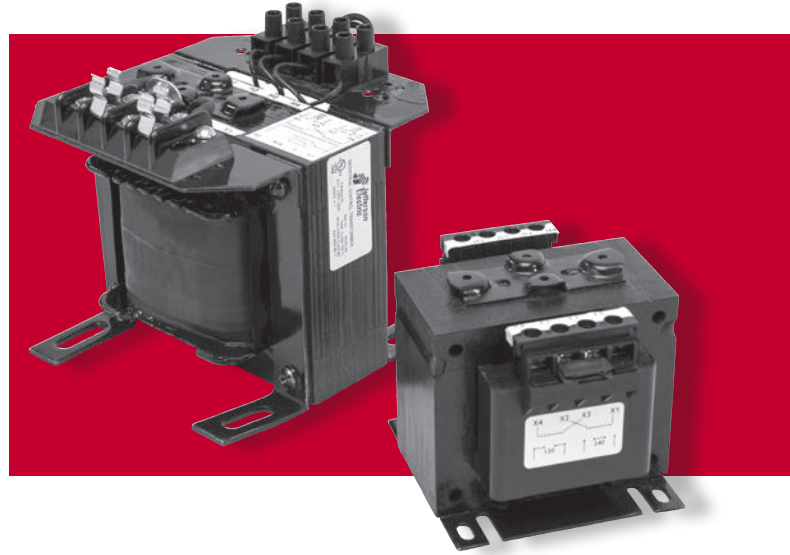

Standards

- Built in accordance with ANSI, and UL standards
- UL and cUL listed

Options and Accessories

- Other sizes and voltages available
- Units can be ordered with primary fuse blocks and covers factory installed
- Optional primary fuse block for 13/32 x 1-1/2 class cc rejection fuse available
- CE Marked units available

Approvals



Enclosure Figures

Figure 30

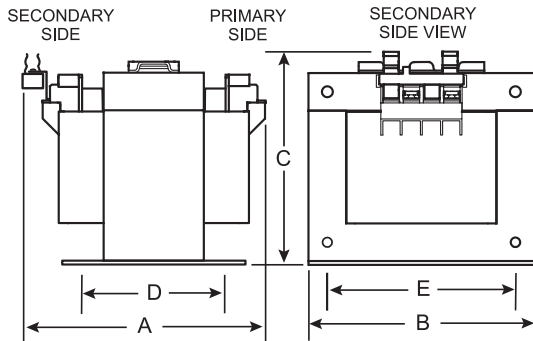
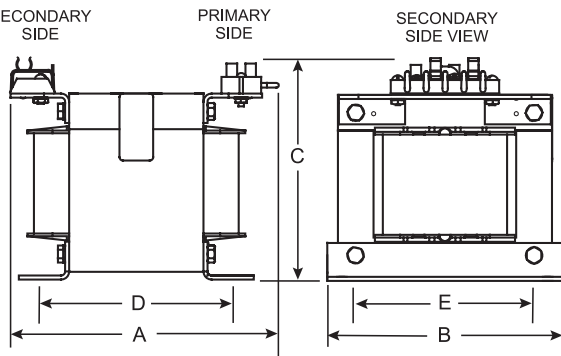

Figure 31



NOTE: Models with catalog numbers ending in “301” do not have a secondary fuseclip

Model Numbers Defined

631-XXYY-ABC

Single-Phase, Encapsulated

kVA Rating / XX		kVA Rating / XX	
0.050	11	0.500	19
0.075	12	0.750	20
0.100	13	1.000	21
0.150	14	1.500	22
0.200	15	2.000	23
0.250	16	3.000	24
0.300	17	4.000	25
0.350	18	5.000	26

Primary	Secondary	
none	none	00
220/230/240 x440/460/480	110/115/120	01
240x480	24	02
120x240	24	03
550/575/600	110/115/120	04
277x208	120	05
460x230x208	115	06
230x460x575	95, 115	07
380x400x415	110x220	08
200/208 x220/230/240 x440/460/480	23/24/25, 110/115/120	09
240x480	120x240	10
208-600	85-130	11
220/230/240	110/115/120	12
x440/460/480 240x347x380	x220/230/240 120x240	13

Variations

Secondary fuseclip included	300
No secondary fuseclip possible	301
Primary fuse kit installed with secondary fuseclip	500
Primary fuse kit installed without secondary fuseclip	501

Industrial Control Transformers

Primary: 220/230/240x440/460/480 V Secondary:110/115/120 V											
kVA	Catalog Number	Enclosure Figure	Height (A) inches	Width (B) inches	Depth (C) inches	(D) inches	(E) inches	Est Ship Wgt	Temp Rise	Insulation	Wiring Diagram
0.05	631-1101-300	30	3.64	3	3.46	2	2.5	2.6	55	180°C	Group AA
0.075	631-1201-300	30	4.1	3	3.46	2.5	2.5	3.5	55	180°C	Group AA
0.1	631-1301-300	30	4.1	3.31	3.46	2.38	2.81	4.2	55	180°C	Group AA
0.15	631-1401-300	30	4.54	3.75	3.94	2.88	3.13	6.7	80	180°C	Group AA
0.2	631-1501-300	30	4.37	4.5	4.46	2.5	3.75	8.5	80	180°C	Group AA
0.25	631-1601-300	30	4.87	4.5	4.47	2.88	3.75	10	80	180°C	Group AA
0.3	631-1701-300	30	4.87	4.5	4.47	3.25	3.75	11.3	80	180°C	Group AA
0.35	631-1801-300	30	5.6	4.5	4.47	3.75	3.75	13.6	80	180°C	Group AA
0.5	631-1901-300	31	5.75	5.25	5.21	4.25	4.38	19.2	80	180°C	Group AA
0.75	631-2001-300	31	7.00	5.25	5.21	5.38	4.38	28.1	80	180°C	Group AA
1	631-2101-300	31	7.05	7.00	6.02	4.00	6.13	28.1	115	180°C	Group AA
1.5	631-2201-300	31	8.05	7.00	6.02	4.5	6.13	30	115	180°C	Group AA
2	631-2301-300	31	8.80	7.00	6.02	5.13	6.13	38	115	180°C	Group AA
3	631-2401-301	31	7.82	9.00	7.62	4.25	6.50	53	115	180°C	Group AA
5	631-2601-301	31	9.00	9.00	7.62	7.25	7.50	89	115	180°C	Group AA
Primary: 240 x 480 V Secondary: 24 V											
0.05	631-1102-300	30	3.64	3	3.46	2	2.5	2.6	55	180°C	Group BB
0.075	631-1202-300	30	4.1	3	3.46	2.5	2.5	3.5	55	180°C	Group BB
0.1	631-1302-300	30	4.1	3.31	3.46	2.38	2.81	4.2	55	180°C	Group BB
0.15	631-1402-300	30	4.54	3.75	3.94	2.88	3.13	6.7	80	180°C	Group BB
0.2	631-1502-300	30	4.37	4.5	4.46	2.5	3.75	8.5	80	180°C	Group BB
0.25	631-1602-300	30	4.87	4.5	4.47	2.88	3.75	10	80	180°C	Group BB
0.3	631-1702-300	30	4.87	4.5	4.47	3.25	3.75	11.3	80	180°C	Group BB
0.35	631-1802-300	30	5.6	4.5	4.47	3.75	3.75	13.6	80	180°C	Group BB
0.5	631-1902-300	31	5.75	5.25	5.21	4.25	4.38	19.2	80	180°C	Group BB
0.75	631-2002-301	31	7.00	5.25	5.21	5.38	4.38	28.1	80	180°C	Group BB
Primary: 120 x 240 V Secondary: 24 V											
0.05	631-1103-300	30	3.64	3	3.46	2	2.5	2.6	55	180°C	Group CC
0.075	631-1203-300	30	4.1	3	3.46	2.5	2.5	3.5	55	180°C	Group CC
0.1	631-1303-300	30	4.1	3.31	3.46	2.38	2.81	4.2	55	180°C	Group CC
0.15	631-1403-300	30	4.54	3.75	3.94	2.88	3.13	6.7	80	180°C	Group CC
0.2	631-1503-300	30	4.37	4.5	4.46	2.5	3.75	8.5	80	180°C	Group CC
0.25	631-1603-300	30	4.87	4.5	4.47	2.88	3.75	10	80	180°C	Group CC
0.3	631-1703-300	30	4.87	4.5	4.47	3.25	3.75	11.3	80	180°C	Group CC
0.35	631-1803-300	30	5.6	4.5	4.47	3.75	3.75	13.6	80	180°C	Group CC
0.5	631-1903-300	31	5.75	5.25	5.21	4.25	4.38	19.2	80	180°C	Group CC
0.75	631-2003-301	31	7.00	5.25	5.21	5.38	4.38	28.1	80	180°C	Group CC

See website for additional kVA, copper windings and temperature options.

Housing dimensions subject to change without notice. Consult website or factory where dimensions are critical.

Use the "Find a Product" tool for detailed specification sheets.

For further information, contact an Application Engineer at 800-892-3755, technical_services@jeffersonelectric.com



Industrial Control Transformers

Primary: 550/575/600 V		Secondary: 110/115/120 V									
kVA	Catalog Number	Enclosure Figure	Height (A) inches	Width (B) inches	Depth (C) inches	(D) inches	(E) inches	Est Ship Wgt	Temp Rise °C	Insulation	Wiring Diagram
0.05	631-1104-300	30	3.64	3	3.46	2	2.5	2.6	55	180°C	Group EE
0.075	631-1204-300	30	4.1	3	3.46	2.5	2.5	3.5	55	180°C	Group EE
0.1	631-1304-300	30	4.1	3.31	3.46	2.38	2.81	4.2	55	180°C	Group EE
0.15	631-1404-300	30	4.54	3.75	3.94	2.88	3.13	6.7	80	180°C	Group EE
0.2	631-1504-300	30	4.37	4.5	4.46	2.5	3.75	8.5	80	180°C	Group EE
0.25	631-1604-300	30	4.87	4.5	4.47	2.88	3.75	10	80	180°C	Group EE
0.3	631-1704-300	30	4.87	4.5	4.47	3.25	3.75	11.3	80	180°C	Group EE
0.35	631-1804-300	30	5.6	4.5	4.47	3.75	3.75	13.6	80	180°C	Group EE
0.5	631-1904-300	31	5.75	5.25	5.21	4.25	4.38	19.2	80	180°C	Group EE
0.75	631-2004-300	31	7.00	5.25	5.21	5.38	4.38	28.1	80	180°C	Group EE
Primary: 208 x 277 V		Secondary: 120 V									
0.05	631-1105-300	30	3.64	3	3.46	2	2.5	2.6	55	180°C	Group FF
0.075	631-1205-300	30	4.1	3	3.46	2.5	2.5	3.5	55	180°C	Group FF
0.1	631-1305-300	30	4.1	3.31	3.46	2.38	2.81	4.2	55	180°C	Group FF
0.15	631-1405-300	30	4.54	3.75	3.94	2.88	3.13	6.7	80	180°C	Group FF
0.2	631-1505-300	30	4.37	4.5	4.46	2.5	3.75	8.5	80	180°C	Group FF
0.25	631-1605-300	30	4.87	4.5	4.47	2.88	3.75	10	80	180°C	Group FF
0.3	631-1705-300	30	4.87	4.5	4.47	3.25	3.75	11.3	80	180°C	Group FF
0.35	631-1805-300	30	5.6	4.5	4.47	3.75	3.75	13.6	80	180°C	Group FF
0.5	631-1905-300	31	5.75	5.25	5.21	4.25	4.38	19.2	80	180°C	Group FF
0.75	631-2005-300	31	7.00	5.25	5.21	5.38	4.38	28.1	80	180°C	Group FF
Primary: 208 x 230 x 460 V		Secondary: 115 V									
0.05	631-1106-300	30	3.64	3	3.46	2	2.5	2.6	55	180°C	Group GG
0.075	631-1206-300	30	4.1	3.31	3.46	2.38	2.81	4.2	55	180°C	Group GG
0.1	631-1306-300	30	4.1	3.31	3.46	2.38	2.81	4.2	55	180°C	Group GG
0.15	631-1406-300	30	4.54	3.75	3.94	2.88	3.13	6.7	80	180°C	Group GG
0.2	631-1506-300	30	4.87	4.5	4.47	2.88	3.75	10	80	180°C	Group GG
0.25	631-1606-300	30	4.87	4.5	4.47	3.25	3.75	11.3	80	180°C	Group GG
0.3	631-1706-300	30	5.6	4.5	4.47	3.75	3.75	13.6	80	180°C	Group GG
0.35	631-1806-300	30	5.6	4.5	4.47	4.75	3.75	15.6	80	180°C	Group GG
0.5	631-1906-300	31	6.25	5.25	5.21	4.75	4.38	21.5	80	180°C	Group GG
0.75	631-2006-300	31	7.00	5.25	5.21	5.38	4.38	30	80	180°C	Group GG
1	631-2106-300	31	7.05	7.00	6.02	4.00	6.13	28.1	115	180°C	Group GG
1.5	631-2206-300	31	7.05	7.00	6.02	4.00	6.13	28.1	115	180°C	Group GG
2	631-2306-300	31	8.80	7.00	6.02	5.13	6.13	38	115	180°C	Group GG
3	631-2406-301	31	7.82	9.00	7.62	4.25	6.50	53	115	180°C	Group GG
5	631-2606-301	31	9.00	9.00	7.62	7.25	7.50	89	115	180°C	Group GG
Primary: 230 x 460 x 575 V		Secondary: 95, 115 V									
1	631-2107-301	31	7.05	7.00	6.02	4	6.13	28.1	115	180°C	Group HH
1.5	631-2207-301	31	8.80	7.00	6.02	5.13	6.13	38	115	180°C	Group HH
2	631-2307-301	31	7.82	9.00	7.62	4.25	6.50	53	115	180°C	Group HH
3	631-2407-301	31	9.00	9.00	7.62	7.25	7.50	89	115	180°C	Group HH
5	631-2607-301	31	9	9	8.74	8.25	7.50	100	115	180°C	Group HH

See website for additional kVA, copper windings and temperature options.
 Housing dimensions subject to change without notice. Consult website or factory where dimensions are critical.
 Use the "Find a Product" tool for detailed specification sheets.
 For further information, contact an Application Engineer at 800-892-3755, technical_services@jeffersonelectric.com

Industrial Control Transformers

Primary: 380 x 400 x 415 V Secondary: 110 x 220 V											
kVA	Catalog Number	Enclosure Figure	Height (A) inches	Width (B) inches	Depth (C) inches	(D) inches	(E) inches	Est Ship Wgt	Temp Rise °C	Insulation	Wiring Diagram
0.05	631-1108-301	30	3.64	3	3.46	2	2.5	2.6	55	180°C	Group II
0.075	631-1208-301	30	4.1	3	3.46	2.5	2.5	3.5	55	180°C	Group II
0.1	631-1308-301	30	4.1	3.31	3.46	2.38	2.81	4.2	55	180°C	Group II
0.15	631-1408-301	30	4.54	3.75	3.94	2.88	3.13	6.7	80	180°C	Group II
0.2	631-1508-301	30	4.37	4.5	4.46	2.5	3.75	8.5	80	180°C	Group II
0.25	631-1608-301	30	4.87	4.5	4.47	2.88	3.75	10	80	180°C	Group II
0.3	631-1708-301	30	4.87	4.5	4.47	3.25	3.75	11.3	80	180°C	Group II
0.35	631-1808-301	30	5.6	4.5	4.47	3.75	3.75	13.6	80	180°C	Group II
0.5	631-1908-301	31	5.75	5.25	5.21	4.25	4.38	19.2	80	180°C	Group II
0.75	631-2008-301	31	7.00	5.25	5.21	5.38	4.38	28.1	80	180°C	Group II
Primary: 200/208x220/230/240x440/460/480 V Secondary: 23/24/25 (Full Load),110/115/120 V											
0.05	631-1109-301	30	4.6	3	3.46	2.88	2.5	4.2	55	180°C	Group JJ
0.075	631-1209-301	30	4.54	3.75	3.94	2.88	3.13	6.7	55	180°C	Group JJ
0.1	631-1309-301	30	4.54	3.75	3.94	2.88	3.13	6.7	55	180°C	Group JJ
0.15	631-1409-301	30	4.54	3.75	3.94	2.88	3.13	6.7	80	180°C	Group JJ
0.2	631-1509-301	30	4.87	4.5	4.47	2.88	3.75	10	80	180°C	Group JJ
0.25	631-1609-301	30	5.6	4.5	4.47	3.75	3.75	13.6	80	180°C	Group JJ
0.3	631-1709-301	31	5.53	5.25	5.66	3.88	4.38	19.2	80	180°C	Group JJ
0.35	631-1809-301	31	5.53	5.25	5.66	3.88	4.38	19.2	80	180°C	Group JJ
0.5	631-1909-301	31	6.25	5.25	5.21	4.75	4.38	21.5	80	180°C	Group JJ
Primary: 240 x 480 V Secondary: 120/240 V											
0.05	631-1110-301	30	3.64	3	3.46	2	2.5	2.6	55	180°C	Group KK
0.075	631-1210-301	30	4.1	3	3.46	2.5	2.5	3.5	55	180°C	Group KK
0.1	631-1310-301	30	4.1	3.31	3.46	2.38	2.81	4.2	55	180°C	Group KK
0.15	631-1410-301	30	4.54	3.75	3.94	2.88	3.13	6.7	80	180°C	Group KK
0.2	631-1510-301	30	4.37	4.5	4.46	2.5	3.75	8.5	80	180°C	Group KK
0.25	631-1610-301	30	4.87	4.5	4.47	2.88	3.75	10	80	180°C	Group KK
0.3	631-1710-301	30	4.87	4.5	4.47	3.25	3.75	11.3	80	180°C	Group KK
0.35	631-1810-301	30	5.6	4.5	4.47	3.75	3.75	13.6	80	180°C	Group KK
0.5	631-1910-301	31	5.75	5.25	5.21	4.25	4.38	19.2	80	180°C	Group KK
0.75	631-2010-301	31	7.00	5.25	5.21	5.38	4.38	28.1	80	180°C	Group KK
1	631-2110-301	31	7.00	5.25	5.21	5.38	4.38	28.1	115	180°C	Group KK
1.5	631-2210-301	31	8.05	7.00	6.02	4.50	6.13	30	115	180°C	Group KK
3	631-2410-301	31	7.82	9.00	7.62	4.25	6.50	53	115	180°C	Group KK
Primary: 208-600 V Secondary: 85 - 130 V											
0.05	631-1111-301	30	4.1	3.31	3.46	2.38	2.81	4.2	55	180°C	Group LL
0.1	631-1311-301	30	4.54	3.75	3.94	2.88	3.13	6.7	55	180°C	Group LL
0.15	631-1411-301	30	4.87	4.5	4.47	2.88	3.75	10	80	180°C	Group LL
0.25	631-1611-301	30	5.53	5.25	5.66	3.88	4.38	19.2	80	180°C	Group LL
0.35	631-1811-301	31	6.53	5.25	5.66	4.38	4.38	21.5	80	180°C	Group LL
0.5	631-1911-301	31	7.00	5.25	5.21	5.21	5.38	30	80	180°C	Group LL
0.75	631-2011-301	31	7.05	7.00	6.02	4.00	6.13	28.1	80	180°C	Group LL

See website for additional kVA, copper windings and temperature options.
 Housing dimensions subject to change without notice. Consult website or factory where dimensions are critical.
 Use the "Find a Product" tool for detailed specification sheets.
 For further information, contact an Application Engineer at 800-892-3755, technical_services@jeffersonelectric.com



Industrial Control Transformers

Primary: 220/230/240x440/460/480 V Secondary: 110/115/120x220/230/240 V											
kVA	Catalog Number	Enclosure Figure	Height (A) inches	Width (B) inches	Depth (C) inches	(D) inches	(E) inches	Est Ship Wgt	Temp Rise °C	Insulation	Wiring Diagram
1	631-2112-301	31	7.00	5.25	5.21	5.38	4.38	28.1	115	180°C	Group MM
1.5	631-2212-301	31	7.05	7.00	6.02	4.00	6.13	28.1	115	180°C	Group MM
2	631-2312-301	31	8.80	7.00	6.02	5.13	6.13	38	115	180°C	Group MM
3	631-2412-301	31	7.82	9.00	7.62	4.25	6.50	53	115	180°C	Group MM
5	631-2612-301	31	9.00	9.00	7.62	7.25	7.50	89	115	180°C	Group MM
Primary: 240 x 347 x 380 V Secondary: 120/240 V											
1	631-2113-301	31	7.05	7.00	6.02	4.00	6.13	28.1	115	180°C	Group NN
1.5	631-2213-301	31	7.05	7.00	6.02	4.00	6.13	28.1	115	180°C	Group NN
2	631-2313-301	31	8.80	7.00	6.02	5.13	6.13	38	115	180°C	Group NN
3	631-2413-301	31	7.82	9.00	7.62	4.25	6.50	53	115	180°C	Group NN
5	631-2613-301	31	9.00	9.00	7.62	7.25	7.50	89	115	180°C	Group NN

See website for additional kVA, copper windings and temperature options.
 Housing dimensions subject to change without notice. Consult website or factory where dimensions are critical.
 Use the "Find a Product" tool for detailed specification sheets.
 For further information, contact an Application Engineer at 800-892-3755, technical_services@jeffersonelectric.com

Wiring Diagrams

Group AA Wiring Diagram & Connections

Wiring Diagram

Primary: 240/230/220 x 480/460/440 Volts
 Secondary: 120/115/110 Volts

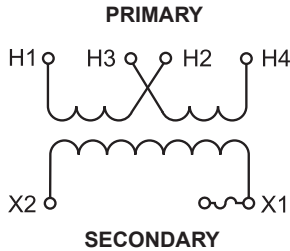

Connections

Primary Volts	Interconnect	Primary Lines Connect To
240/230/220	H1-H3, H2-H4	H1, H4
480/460/440	H2-H3	H1, H4
Secondary Volts	Secondary Lines Connect To	
120/115/110	X2, XF	

Group BB Wiring Diagram & Connections

Wiring Diagram

Primary: 480 x 240 Volts
 Secondary: 24 Volts

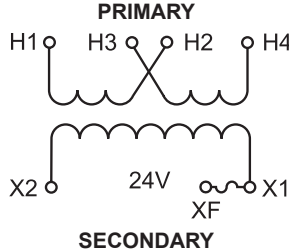

Connections

Primary Volts	Interconnect	Primary Lines Connect To
480	H2-H3	H1, H4
240	H1-H3, H2-H4	H1, H4
Secondary Volts	Secondary Lines Connect To	
24	X2, XF	

Group CC Wiring Diagram & Connections

Wiring Diagram

Primary: 240 x 120 Volts
 Secondary: 24 Volts

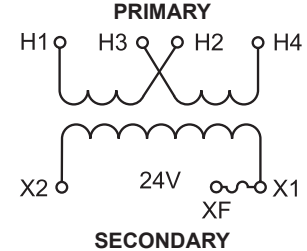

Connections

Primary Volts	Interconnect	Primary Lines Connect To
240	H2-H3	H1, H4
120	H1-H3, H2-H4	H1, H4
Secondary Volts	Secondary Lines Connect To	
24	X2, XF	

Use the "Find a Product" tool on our website for detailed specification sheets.
 For further information, contact an Application Engineer at 800-892-3755, technical_services@jeffersonelectric.com

Wiring Diagrams

Group EE Wiring Diagram & Connections

Wiring Diagram

Primary: 600/575/550 Volts
Secondary: 120/115/110 Volts

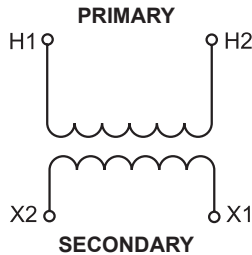

Connections

Primary Volts	Primary Lines Connect To
600/575/550	H1, H2
Secondary Volts	Secondary Lines Connect To
120/115/110	X2, X1

Group FF Wiring Diagram & Connections

Wiring Diagram

Primary: 277 x 208 Volts
Secondary: 120 Volts

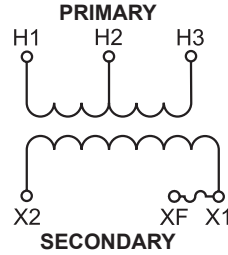

Connections

Primary Volts	Primary Lines Connect To
277	H1, H3
208	H1, H2
Secondary Volts	Secondary Lines Connect To
120	X2, XF

Group GG Wiring Diagram & Connections

Wiring Diagram

Primary: 460 x 230 x 208 Volts
Secondary: 115 Volts

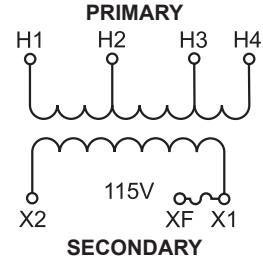

Connections

Primary Volts	Primary Lines Connect To
460	H1, H4
230	H1, H3
208	H1, H2
Secondary Volts	Secondary Lines Connect To
115	X2, XF

Group HH Wiring Diagram & Connections

Wiring Diagram

Primary: 575 x 460 x 230 Volts
Secondary: 115 x 95 Volts

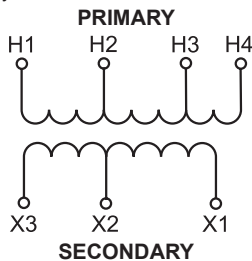

Connections

Primary Volts	Primary Lines Connect To
575	H1, H4
460	H1, H3
230	H1, H2
Secondary Volts	Secondary Lines Connect To
115	X1, X3
95	X1, X2

Group II Wiring Diagram & Connections

Wiring Diagram

Primary: 415 x 400 x 380 Volts
Secondary: 110 x 220 Volts

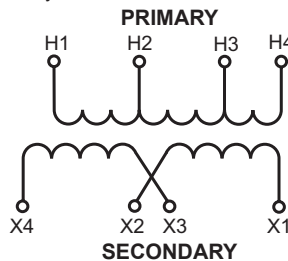

Connections

Primary Volts	Primary Lines Connect To
415	H1, H4
400	H1, H3
380	H1, H2
Secondary Volts	Secondary Lines Connect To
110	X1-X3, X2-X4
220	X2-X3

Group JJ Wiring Diagram & Connections

Wiring Diagram

Primary: 460 x 230 x 208 Volts
Secondary: 115 x 24 Volts

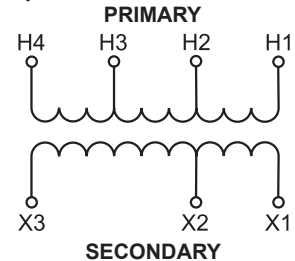

Connections

Primary Volts	Primary Lines Connect To
480/460/440 V	H1, H4
240/230/220 V	H1, H3
208/200 V	H1, H2
Secondary Volts	Secondary Lines Connect To
120/115/110 V	X1, X3
25/24/23 V	X1, X2

Wiring Diagrams

Group KK Wiring Diagram & Connections

Wiring Diagram

Primary: 480 x 240 Volts
Secondary: 120 x 240 Volts

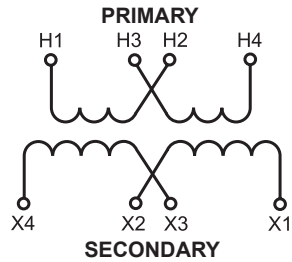

Connections

Primary Volts	Interconnect	Primary Lines Connect To
480	H2-H3	H1, H4
240	H1-H3, H2-H4	H1, H4
Secondary Volts	Interconnect	Secondary Lines Connect To
120	X1-X3, X2-X4	X1, X4
240	X2-X3	X1, X4

Group LL Wiring Diagram & Connections

Wiring Diagram

Primary: 240 x 416 x 480 x 600 Volts
Secondary: 130 x 120 x 99 Volts

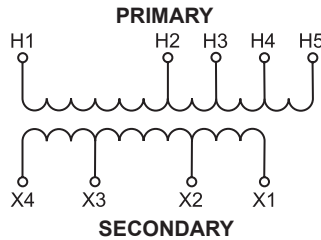

Connections

Primary Volts	Primary Lines Connect To
240/230/220/208	H2, H1
416/400/380	H3, H1
480/460/440	H4, H1
600/575/550/500	H5, H1
Secondary Volts	Secondary Lines Connect To
130/125/120/110	X4, X1
120/115/110/100	X3, X1
99/95/91/85	X2, X1

Group MM Wiring Diagram & Connections

Wiring Diagram

Primary: 480/460/440 x 240/230/220 Volts
Secondary: 120/115/110 x 240/230/220 Volts

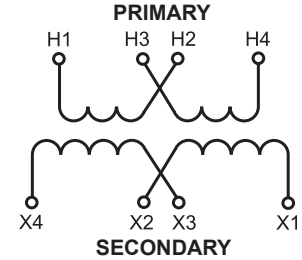

Connections

Primary Volts	Interconnect	Primary Lines Connect To
480/460/440	H2-H3	H1, H4
240/230/220	H1-H3, H2-H4	H1, H4
Secondary Volts	Interconnect	Secondary Lines Connect To
120/115/110	X1-X3, X2-X4	X2, X4
240/230/220	X2-X3	X1, X4

Group NN Wiring Diagram & Connections

Wiring Diagram

Primary: 380 x 347 x 240 Volts
Secondary: 120 x 240 Volts

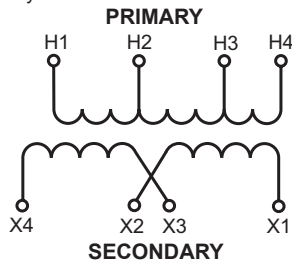

Connections

Primary Volts	Primary Lines Connect To
380	H1, H4
347	H1, H3
240	H1, H2
Secondary Volts	Secondary Lines Connect To
120	X1-X3, X2-X4
240	X2-X3

Use the "Find a Product" tool on our website for detailed specification sheets. For further information, contact an Application Engineer at 800-892-3755, technical_services@jeffersonelectric.com

Accessories

Item	Catalog Number	Figure	Dimensions	Estimated Shipping Wgt	Description
Primary Fuse Kit (Maximum 2,000 VA)	631-0000-301	16	Adds approx 1.38" to C dimension	0.35 lbs.	Fuse kit for one transformer
Primary Fuse Covers +	631-0000-302	17	Adds approx .25" to C dimension (1.65" total with fuse kit)	0.10 lbs.	Cover for one fuse kit
Finger Safe Terminal Covers	631-0000-303	32	Adds approx .25" to C dimension	0.10 lbs.	Covers for one transformer for units larger than 350 VA
Secondary Fuse Cover	631-0000-307		Adds approx .25" to C dimension	0.10 lbs.	Cover for one transformer 350 VA and smaller

Figure 16

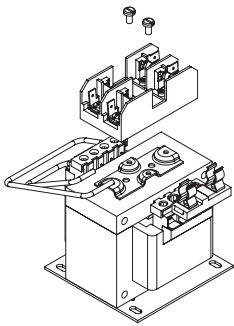

Figure 17

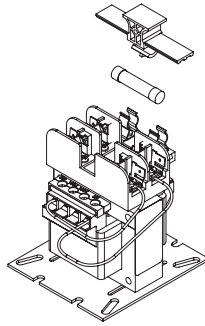
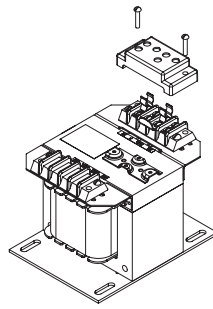

Figure 32



- The optional primary fuse block is for a 13/32 x 1-1/2 class cc rejection fuse. The primary fuse should always have a time delay, slow blow properly sized for the application.
- The standard secondary fuse clip is for a 13/32 x 1-1/2 midget fuse. The secondary fuse style is a matter of customer preference usually either time delay or fast acting.

