

# STANDARD ENCLOSURE AND MOUNTING DIMENSIONS

General Purpose Transformer, NEMA 3R, 3 phase, 600V, 115°C rise

## Non-Linear K-13

### General Specifications

Type:	Ventilated
Temp Rise:	115°C
K-Factor:	K-13
Frequency:	60 Hz
Windings:	Aluminum or Copper
Efficiency:	DOE-2016

Measurements in inches/pounds below;  
metric dimensions on other side.

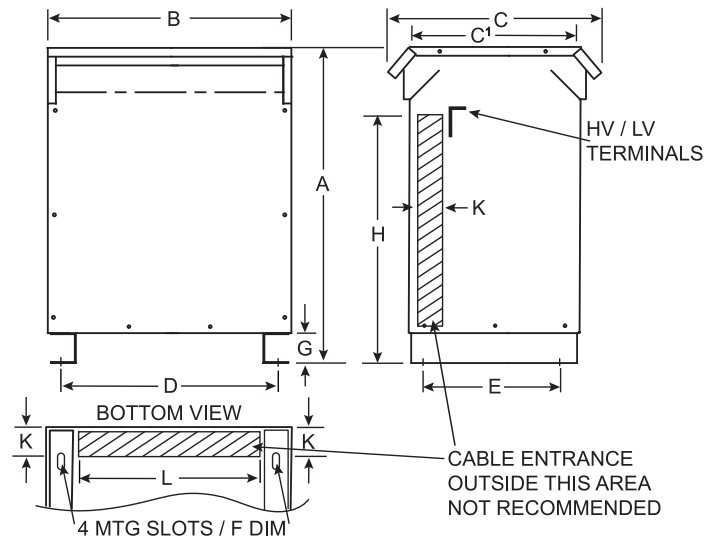

### Dimensions in inches

kVA	Net Wt (lbs)		A	B	C	C'	D	E	F	G	H	K	L
	AL	CU											
15	360	390	25.0	22.0	22.0	17.0	18.1	13.0	0.56 x 1.13	3.0	19.0	3.0	15.0
30	480	525	28.0	25.0	23.5	18.5	20.8	14.5	0.56 x 1.13	3.0	22.0	3.0	17.0
45	625	690	32.0	27.0	26.0	21.0	23.5	16.0	0.56 x 1.13	3.0	26.0	3.0	20.0
75	875	965	38.0	29.0	28.5	23.0	25.5	18.0	0.56 x 1.13	3.0	32.0	3.0	22.0
112.5	1225	1350	42.0	33.0	32.5	26.0	30.0	21.0	0.56 x 1.13	3.0	35.0	4.0	25.5
150	1545	1700	46.0	35.0	37.0	30.0	31.5	25.0	0.56 x 1.13	3.0	39.0	5.0	27.5
225	1895	2050	52.0	35.0	37.0	30.0	31.5	25.0	0.56 x 1.13	3.0	45.0	5.0	27.5
300	3220	3550	60.0	48.0	43.5	38.0	42.0	27.0	0.56 x 1.13	4.0	47.0	5.0	38.0
500	4250	4665	72.2	52.0	44.2	40.0	47.0	42.0	0.56 x 1.13	4.0	56.0	5.0	44.25

Housing dimensions subject to change without notice. Consult factory where dimensions are critical.

### NOTES:

- All units are UL listed and are designed in accordance with ANSI C89.2 and NEMA ST-20 standards
- These transformers utilize a UL recognized 220°C insulation system
- Transformers are dry type, Class AA, ventilated enclosure for indoor or outdoor use
- For lifting other than with fork truck, remove top cover and use core clamps
- Paint color is ANSI #61 Gray
- Full width copper electrostatic shield (optional)
- 6" required clearance from the wall
- HV/LV terminals are top front terminated
- Meets DOE-2016 efficiency 10 CFR Part 431
- Meets NRCAN C802 2019 standards for efficiency
- Net Weights are approximate



800-892-3755

PCD 423-900A-115-K13



jeffersonelectric.com



bemag.ca

# STANDARD ENCLOSURE AND MOUNTING DIMENSIONS

General Purpose Transformer, NEMA 3R, 3 phase, 600V, 115°C rise

## Non-Linear K-13

### General Specifications

Type:	Ventilated
Temp Rise:	115°C
K-Factor:	K-13
Frequency:	60 Hz
Windings:	Aluminum or Copper
Efficiency:	DOE-2016

Measurements in centimeters/kilograms below;  
inches/pounds dimensions on other side.

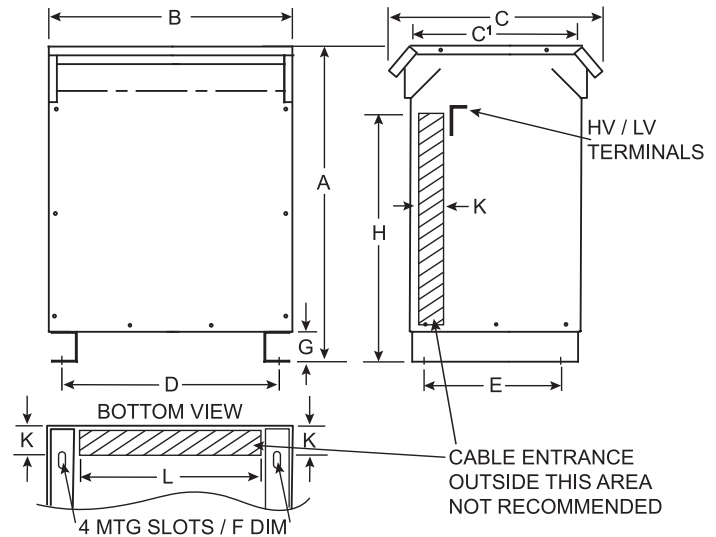

### Dimensions in centimeters

kVA	Net Wt (kg)		A	B	C	C'	D	E	F	G	H	K	L
	AL	CU											
15	163.3	176.9	63.5	55.9	55.9	43.2	46.0	33.0	1.42 x 2.87	7.6	48.3	7.6	38.1
30	217.7	238.1	71.1	63.5	59.7	47.0	52.8	36.8	1.42 x 2.87	7.6	55.9	7.6	43.2
45	283.5	313.0	81.3	68.6	66.0	53.3	59.7	40.6	1.42 x 2.87	7.6	66.0	7.6	50.8
75	396.9	437.7	96.5	73.7	72.4	58.4	64.8	45.7	1.42 x 2.87	7.6	81.3	7.6	55.9
112.5	555.7	612.3	106.7	83.8	82.6	66.0	76.2	53.3	1.42 x 2.87	7.6	88.9	10.2	64.8
150	700.8	771.1	116.8	88.9	94.0	76.2	80.0	63.5	1.42 x 2.87	7.6	99.1	12.7	69.9
225	859.6	929.9	132.1	88.9	94.0	76.2	80.0	63.5	1.42 x 2.87	7.6	114.3	12.7	69.9
300	1460.6	1610.3	152.4	121.9	110.5	96.5	106.7	68.6	1.42 x 2.87	10.2	119.4	12.7	96.5
500	1927.8	2116.0	183.4	132.1	112.3	101.6	119.4	106.7	1.42 x 2.87	10.2	142.2	12.7	112.4

Housing dimensions subject to change without notice. Consult factory where dimensions are critical.

### NOTES:

- All units are UL listed and are designed in accordance with ANSI C89.2 and NEMA ST-20 standards
- These transformers utilize a UL recognized 220°C insulation system
- Transformers are dry type, Class AA, ventilated enclosure for indoor or outdoor use
- For lifting other than with fork truck, remove top cover and use core clamps
- Paint color is ANSI #61 Gray
- Full width copper electrostatic shield (optional)
- 6" required clearance from the wall
- HV/LV terminals are top front terminated
- Meets DOE-2016 efficiency 10 CFR Part 431
- Meets NRCAN C802 2019 standards for efficiency
- Net Weights are approximate



800-892-3755

PCD 423-900A-115-K13



jeffersonelectric.com



bemag.ca